

JVC



ENGLISH

ESPAÑOL

FRANÇAIS

MOBILE TV TUNER SYSTEM SISTEMA DE SINTONIZADOR DE TV MÓVIL SYSTÈME DE TUNER DE TÉLÉVISION MOBILE

KV-C1 (with internal diversity antenna and wireless remote controller) (con antena de diversidad interna y controlador remote inalámbrico) (avec antenne de réception en diversité et module de télécommande sans cordon)

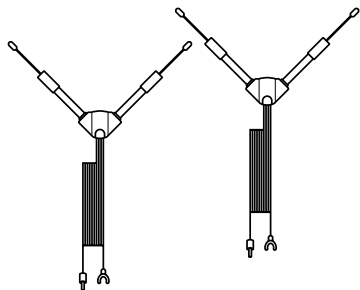

Diversity antenna
Antena de diversidad
Antenne de réception en diversité

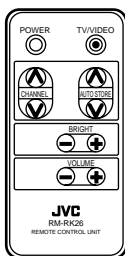

Wireless remote controller
Controlador remoto inalámbrico
Module de télécommande sans cordon

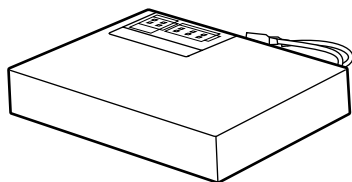

Tuner unit
Sintonizador
Unité de tuner

For installation and connections, refer to the separate manual.

Para realizar la instalación y las conexiones, consulte el manual separado.

Pour l'installation et les raccordements, se référer au manuel séparé.

* For optional view of TV broadcast, it is necessary to connect the tuner unit with the JVC mobile color monitor system KV-M65 (sold separately).

* Para ver opcionalmente una emisión de TV resulta necesario conectar el sintonizador con el sistema de monitor en color móvil JVC modelo KV-M65 (vendido separadamente).

* Pour un visionnement optionnel des émissions de télévision, il faudra raccorder le tuner avec système de moniteur couler mobile JVC KV-M65 (vendu séparément).

INSTRUCTIONS **MANUAL DE INSTRUCCIONES** **MANUEL D'INSTRUCTIONS**

For customer Use:

Enter below the serial No. which is located on the rear of cabinet. Retain this information for future reference.

Model No. **KV-C1**

Serial No. _____

Safety points (Be sure to follow these points)

CAUTIONS

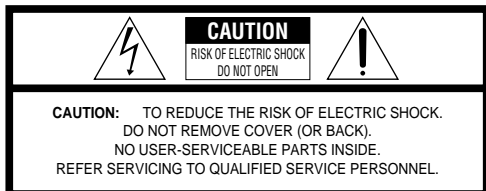

The lightning flash with arrowhead symbol, within an equilateral triangle, is intended to alert the user to the presence of uninsulated "dangerous voltage" within the product's enclosure that may be of sufficient magnitude to constitute a risk of electric shock to persons.



The exclamation point within an equilateral triangle is intended to alert the user to the presence of important operating and maintenance (servicing) instructions in the literature accompanying the appliance.

WARNING:

TO PREVENT FIRE OR SHOCK HAZARD, DO NOT EXPOSE THIS UNIT TO RAIN OR MOISTURE.

CAUTION:

This TV tuner system should be used with DC 12V only. To prevent electric shocks and fire hazards, DO NOT use any other power source.

This Class B digital apparatus meets all requirements of the Canadian Interference-Causing Equipment Regulations.

"Cet appareil numérique de la classe B respecte toutes les exigences du Règlement sur le matériel brouilleur du Canada."

Warnings

- THE DRIVER MUST NOT OPERATE THE TV TUNER SYSTEM WHILE DRIVING. OPERATING THE TV TUNER SYSTEM WHILE DRIVING MAY LEAD TO CARELESSNESS AND CAUSE AN ACCIDENT.
* STOP YOUR VEHICLE IN A SAFE LOCATION WHEN OPERATING THE TV TUNER SYSTEM.
- THE DRIVER MUST NOT WATCH THE TELEVISION OR VIDEOS WHILE DRIVING. IF THE DRIVER WATCHES THE TELEVISION OR A VIDEO WHILE DRIVING, IT MAY LEAD TO CARELESSNESS AND CAUSE AN ACCIDENT.
- DO NOT USE THE TV TUNER SYSTEM WHEN THERE IS A PROBLEM OR MALFUNCTION. IF THE TV TUNER SYSTEM IS USED IN AN ABNORMAL CONDITION SUCH AS WHEN THE TV TUNER SYSTEM IS EMITTING SMOKE OR AN UNUSUAL SMELL, IT MAY CAUSE A FIRE OR SOME OTHER PROBLEM.
* IMMEDIATELY STOP USING THE TUNER SYSTEM AND CONSULT THE SALES OUTLET WHERE YOU PURCHASED THE TUNER SYSTEM.
- DO NOT TAKE THE TV TUNER SYSTEM APART OR MAKE ANY CHANGES. IF THE TUNER SYSTEM IS TAKEN APART OR CHANGED IN ANY WAY, IT MAY CAUSE MALFUNCTIONS OR A FIRE OR OTHER ACCIDENT.
- DO NOT PUT YOUR EYES OR FACE NEAR THE ANTENNA ELEMENT. IF YOU PUT YOUR EYES OR FACE NEAR THE ANTENNA ELEMENT, YOU COULD BE INJURED.
- STORE THE BATTERIES IN A PLACE WHICH CHILDREN CANNOT REACH.
* IF A CHILD SOMEHOW INGESTS THE BATTERY, IMMEDIATELY CONSULT A DOCTOR.
- DO NOT RECHARGE, SHORT, DISASSEMBLE OR HEAT THE BATTERIES OR PUT THEM IN A FLAME. DOING ANY OF THESE THINGS MAY CAUSE THE BATTERIES TO GIVE OFF HEAT, CRACK OR START A FIRE.
- DO NOT MIX THE BATTERIES WITH OTHER METALS. DOING THIS MAY CAUSE THE BATTERIES TO GIVE OFF HEAT, CRACK OR START A FIRE.
- WHEN THROWING AWAY OR SAVING THE BATTERIES, WRAP IN TAPE AND INSULATE. IF THIS IS NOT DONE, IT MAY CAUSE THE BATTERIES TO GIVE OFF HEAT, CRACK OR START A FIRE.
- DO NOT POKER THE BATTERIES WITH A METAL PIN SET OR SIMILAR DEVICE. IF THIS IS NOT DONE, IT MAY CAUSE THE BATTERIES TO GIVE OFF HEAT, CRACK OR START A FIRE.

Safety Points (continued) (Be sure to follow these points)

CAUTION :

Change or modifications not approved by JVC could void user's authority to operate the equipment. This equipment has been tested and found to comply with the limits for a Class B digital device, pursuant to Part 15 of the FCC Rules. These limits are designed to provide reasonable protection against harmful interference in a residential installation. This equipment generates, uses, and can radiate radio frequency energy and, if not installed and used in accordance with the instructions, may cause harmful interference to radio communications.

However, there is no guarantee that interference will not occur in a particular installation. If this equipment does cause harmful interference to radio or television reception, which can be determined by turning the equipment off and on, the user is encouraged to try to correct the interference by one or more of the following measures:

Reorient or relocate the receiving antenna.

Increase the separation between the equipment and receiver.

Connect the equipment into an outlet on a circuit different from that to which the receiver is connected.

Consult the dealer or an experienced radio/TV technician for help.

Cautions

- **BE SURE TO INSERT THE BATTERIES PROPERLY IN THE ⊕ ⊖ DIRECTIONS. IF THIS IS NOT DONE, IT MAY CAUSE THE BATTERIES TO GIVE OFF HEAT, CRACK OR START A FIRE.**
- **WHEN LIGHTNING OCCURS, DO NOT TOUCH THE ANTENNA WIRE OR THE TELEVISION. TOUCHING THE ANTENNA WIRE OR THE TELEVISION UNDER SUCH CONDITIONS MAY CAUSE ELECTROCUTION.**
- **KEEP THE TV TUNER SYSTEM AT AN APPROPRIATE SOUND LEVEL WHILE DRIVING. DRIVING WITH THE SOUND AT A LEVEL THAT PREVENTS YOU FROM HEARING SOUNDS OUTSIDE OF AND AROUND THE VEHICLE MAY CAUSE AN ACCIDENT.**
- **ASK A TRAINED TECHNICIAN TO INSTALL THE TV TUNER SYSTEM. INSTALLATION AND WIRING REQUIRE TRAINING AND EXPERIENCE.**
* TO BE SAFE, ASK THE SALES OUTLET WHERE YOU PURCHASED THE TV TUNER SYSTEM TO PERFORM THE INSTALLATION.
- **DO NOT LET THE TV TUNER SYSTEM FALL OR BE STRONGLY IMPACTED. BE SURE TO NOT LET THE TUNER SYSTEM FALL OR BE STRONGLY IMPACTED SINCE THIS MAY CAUSE A MALFUNCTION OR FIRE.**
- **DO NOT WATCH THE MONITOR WITH THE ENGINE OFF. WATCHING THE MONITOR WITH THE ENGINE OFF WILL CONSUME BATTERY POWER AND MAY PREVENT THE ENGINE FROM STARTING.**

Cautions for the liquid crystal panel (sold separately)

- Do not leave the liquid crystal panel surface facing upwards on top of the dashboard. (storage temperature range: -20°C to $+80^{\circ}\text{C}$ (-4°F to $+176^{\circ}\text{F}$))

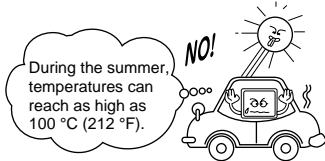
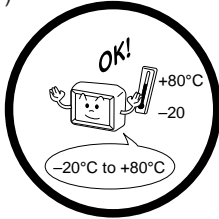

When the liquid crystal panel reaches high temperatures or low temperatures, chemical changes occur within the liquid crystal panel which may cause malfunctions.

- Do not strongly impact the liquid crystal panel.

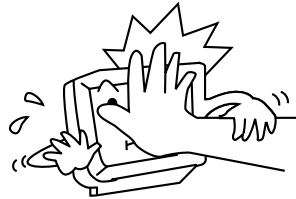

- There are red spots, blue spots and green spots on the panel surface. This is a characteristic of liquid crystal panels and is not a problem.

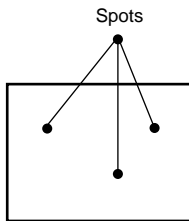

The liquid crystal panel is built with very high precision technology and has at least 99.99% effective image pixels. Be aware that on 0.01% of the panel there may be missing pixels or constantly light pixels.

- When the temperature is very cold or very hot, the image may not appear clearly or may move slowly.

Also, movement of the image may seem to be out of sync or the image quality may decline in such environments. Note that this is not a malfunction or problem.

(usage temperature range: 0°C to 40°C (32°F to 104°F))

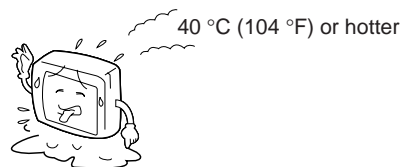
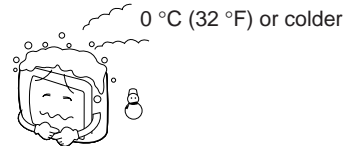

Thank you for purchasing a JVC product. Please read all instructions carefully before operation, to ensure your complete understanding and to obtain the best possible performance from the unit.

Table of Contents

Introduction to the Roles of the System Components	6
How to Use the TV Tuner System	
Watching Television	11
Selecting a Channel	13
Controlling the Sound	16
Adjusting Brightness	19
Adjusting the Sound	23
Adjusting the Image	25
Connecting to External Devices.....	27
How to Best Use the TV Tuner System	
Troubleshooting	28
When You Think There is a Problem	29
Maintenance	30
Specifications.....	31

Introduction to the Roles of the System Components

Tuner unit

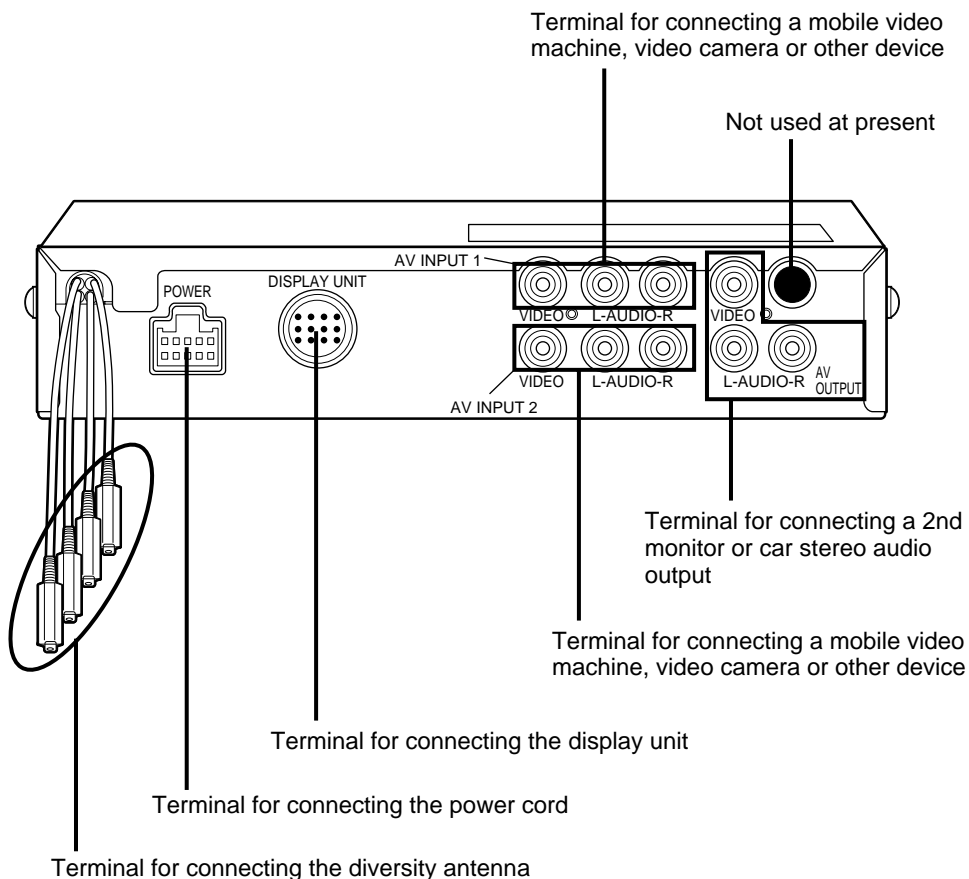

Introduction to the Roles of the System Components (continued)

KV-M65 display unit (sold separately)

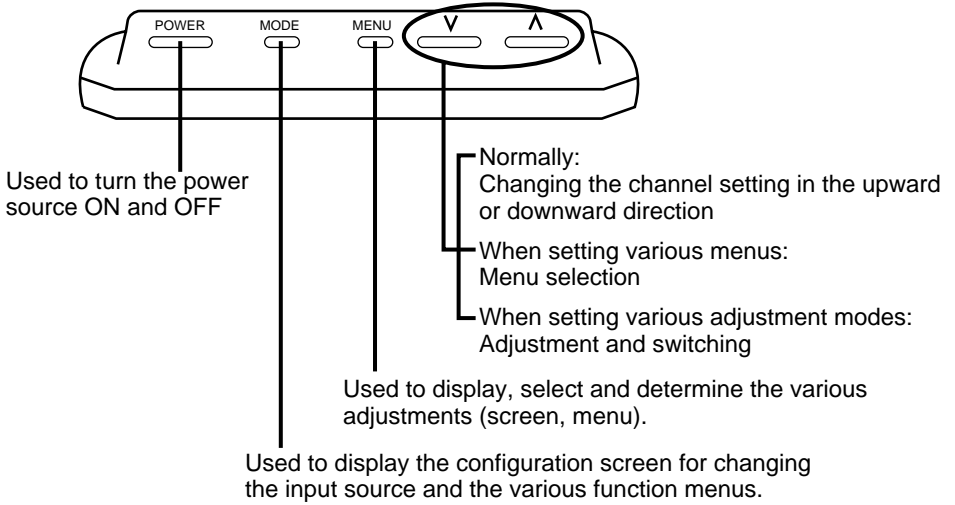

To view TV broadcasts, it is necessary to connect the tuner unit with the JVC mobile color monitor system KV-M65 (sold separately).

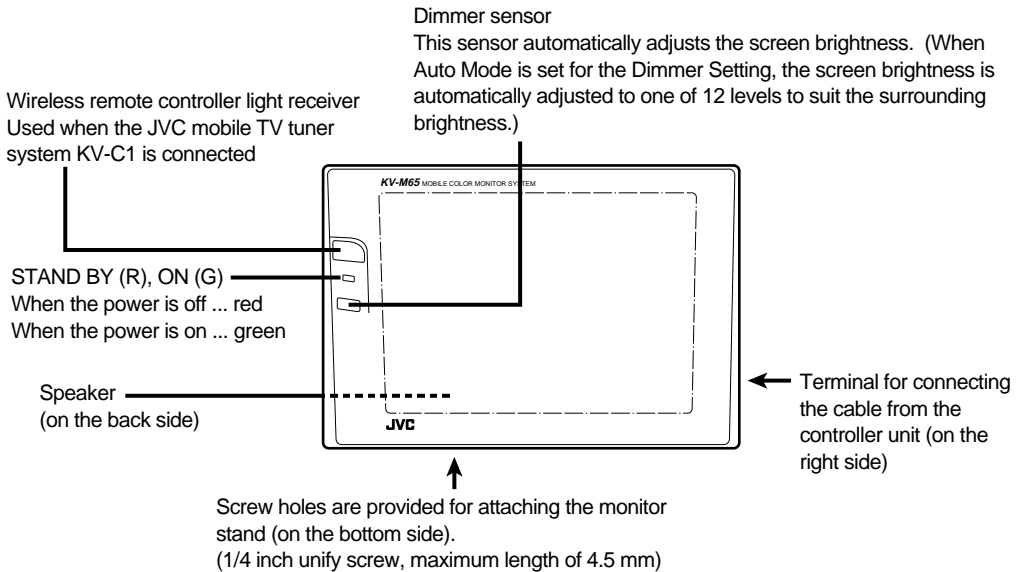

MODE button

When pressed for less than 2 seconds: The input source can be changed.

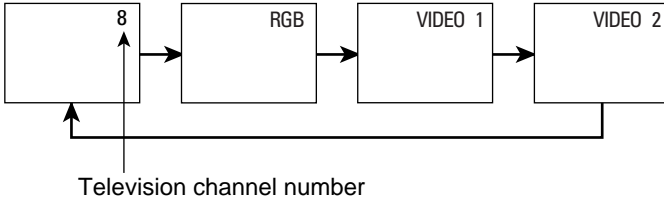

When pressed for 2 seconds or longer: The setting screens for various functions can be displayed.

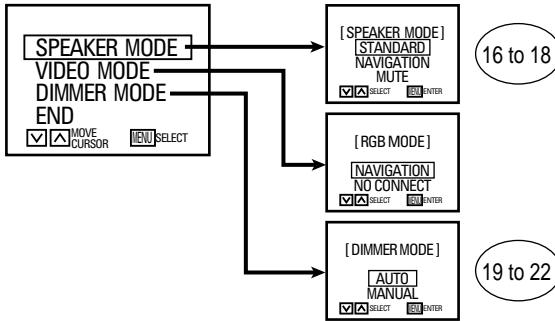

MENU button

When pressed for less than 2 seconds: The adjustment screen display can be selected. (The following diagram shows an example for the Speaker Output Setting on All Modes and the Dimmer Setting on Auto Mode.)

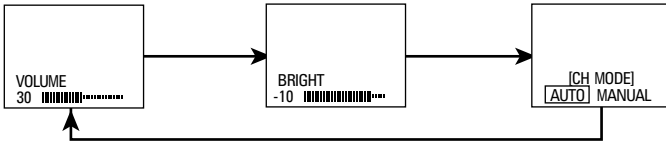

When pressed for 2 seconds or longer: The menus for image and sound can be displayed.

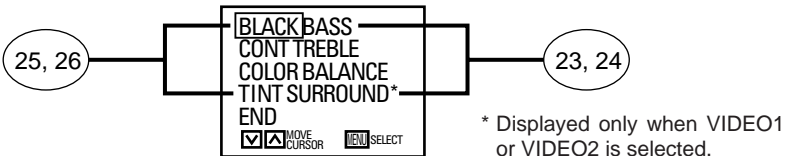

When setting the menus: The Menu selection and adjustment can be decided.

Introduction to the Roles of the System Components (continued)

Wireless remote controller

The numbers in the circles () indicate the page on which an explanation is provided in this manual.

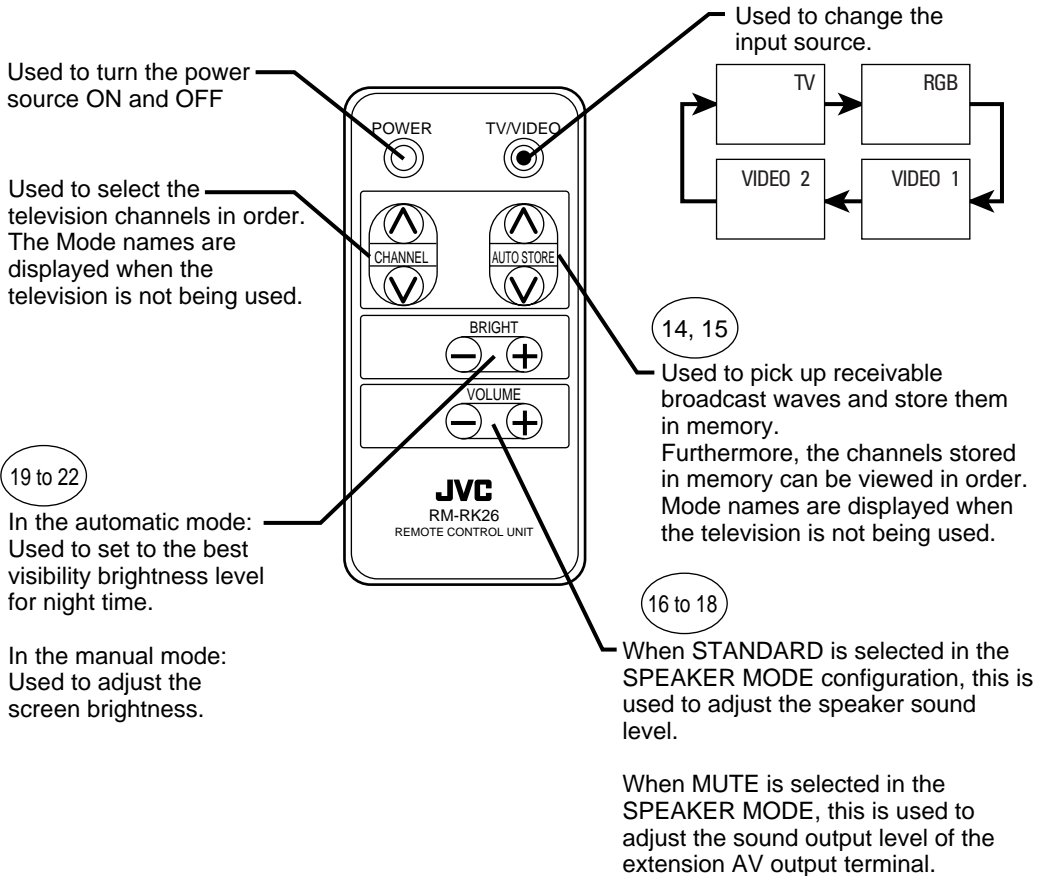

Before using the wireless remote controller

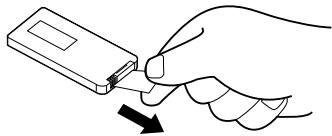

- A battery is already installed in the wireless remote controller. Remove the insulation film before using.

How to replace the battery

When it becomes necessary to bring the wireless remote controller close to the remote sensor for it to work, the battery is running low. At this point, the battery should be replaced. (Battery life is about 1 year with normal use.)

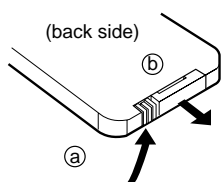

- ① Remove the battery case.
 - ① Push in the direction indicated by the arrow with your right hand thumbnail.
 - ② Remove the battery case.

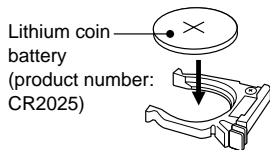

- ② Replace the battery.
Put the battery in the case with the ⊕ side facing upwards.

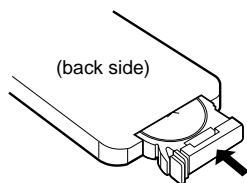

- ③ Return the battery case.
Re-insert the battery case pushing until you hear a clicking sound.

WARNING

- Store the batteries in a place which children cannot reach.
* If a child somehow ingests the battery, immediately consult a doctor.
- Do not recharge, short, disassemble or heat the batteries or put them in a flame.
Doing any of these things may cause the batteries to give off heat, crack or start a fire.
- Do not mix the batteries with other metals.
Doing this may cause the batteries to give off heat, crack or start a fire.
- When throwing away or saving the batteries, wrap in tape and insulate.
If this is not done, it may cause the batteries to give off heat, crack or start a fire.
- Do not poke the batteries with a metal pin set or similar device.
Doing this may cause the batteries to give off heat, crack or start a fire.

Watching Television

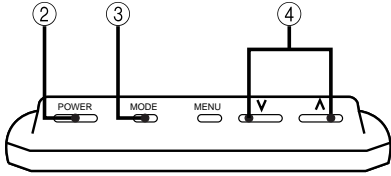

KV-M65 display unit

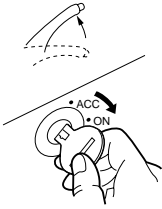
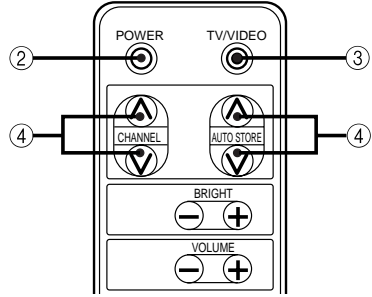

① Engage the parking brake and turn on the engine.

Note

- When the display unit is installed in a location which can be viewed from the driver's seat, the television image disappears while driving and only the sound can be heard.
- The best image is seen by looking straight on at the liquid crystal panel.

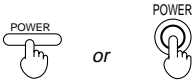

② Turn on the display unit power source.
Changes to the green light and a screen appears in the mode before turning the power source off.
When pushed again, the power source is cut. (red light turns on)

Request

- When AM radio broadcast is received while the display unit power is left on, there may be interference with the car radio. If this occurs, please turn the TV tuner system off.

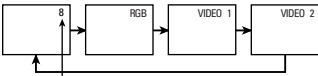

Indicates that channel 8 is received

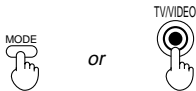

Changes with each push of the button

③ Select the television screen from the input sources.

Note

- Refer to pages 13 to 18 for an explanation of how to select channels or control the sound.

Watching Television (continued)

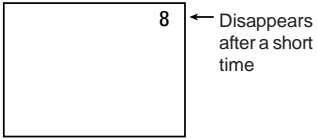

- ④ Select the channel you would like to watch.

Note

- When the bright and dark portions of the screen are inverted or the screen appears white:

Refer to pages 25 and 26 and adjust the Black Level

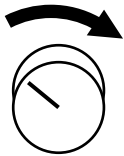
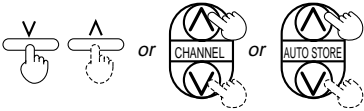

- ⑤ Adjust the sound level of the car receiver connected to the KV-C1 sound output.

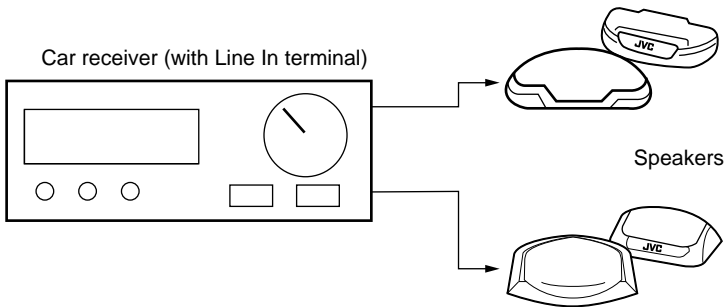

Selecting a Channel

For manual channel selection (changing the channel setting one channel at a time)

(When the remote controller is used, channels can be directly selected using the "CHANNEL" button)

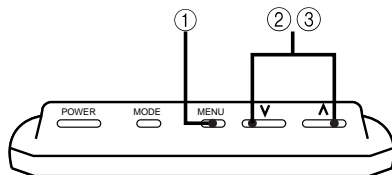

KV-M65 display unit

- ① Press the MENU button 3 times quickly and the CH MODE display is shown.

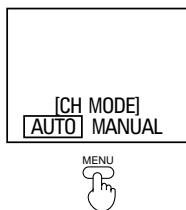

- ② Select MANUAL.

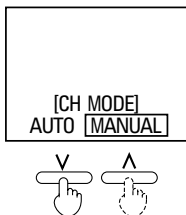

- ③ After the CH MODE display disappears, press the [V] or [^] button for less than 2 seconds and select the channel you would like to watch.

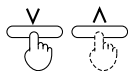

Changes one channel at a time in the direction of smaller numbers



Changes one channel at a time in the direction of larger numbers

Note

- When the [V] or [^] button is pressed for 2 seconds or longer:

The system will automatically select a channel and stop at a channel where broadcast is being received.

Selecting a Channel (continued)

For automatic storage channel selection

(used to view channels in the order in which they are stored in memory)

Operations on the display unit

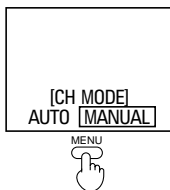
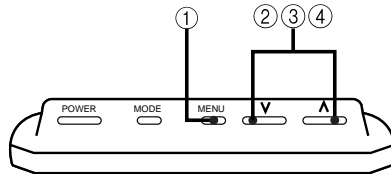

- ① Press the MENU button 3 times quickly and select the CH MODE.

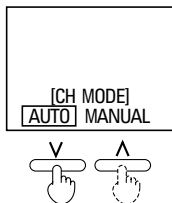

- ② Select AUTO.

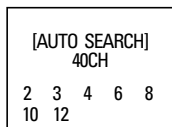

- ③ After the CH MODE display disappears, press the [V] or [^] button for 2 seconds or longer.

Shows the channel numbers stored in memory

Channels stored in memory are seen in order



Changes in the direction of smaller channel numbers



Changes in the direction of larger channel numbers

- ④ When automatic storage is finished, press the [V] or [^] button for less than 2 seconds and select the channel you would like to watch.

Note

- What is automatic storage (Auto Store)?
This function automatically picks up the broadcast waves which can be received in the region where the tuner system is being used and stores them in memory. A memory of channels can be easily added when out on a drive or other location. When the automatic storage function is used, the channels previously stored in the memory are lost.
- When automatic storage is finished:
The system returns to the channel being used prior to the automatic storage operation.
- When you are in a region where the electric waves are weak
It may not be possible to store channels in memory.

Operating the wireless remote controller

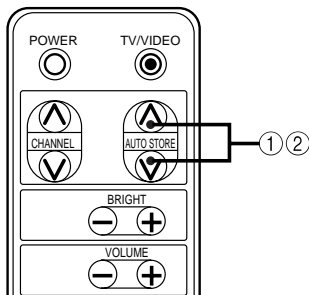

- ① Press the AUTO STORE button for 2 seconds or longer.

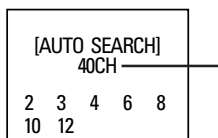

Shows the channel numbers contained in memory.

Shows how far the channel search has gone.



Channels stored in memory can be viewed in order.

- ② When automatic storage is finished, press the [V] or [^] button for less than 2 seconds and select the channel you would like to watch.



Changes in the direction of larger channel numbers

Changes in the direction of smaller channel numbers

Note

- There are times when channels which cannot be viewed are stored in memory. This is not a malfunction or problem.
- The channels stored in the memory by the Auto Store function cannot be erased.
- During Auto Store:
The voice muting circuit is activated and cuts unpleasant noise.

Controlling the Sound

Selecting the volume of the built-in speakers

(The TV tuner system is set to the STANDARD at the time of shipment from the factory.)

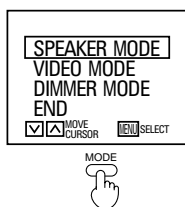
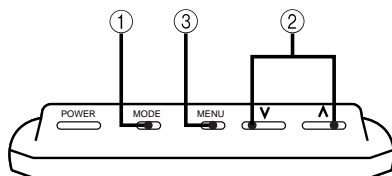

① Press the MODE button for 2 seconds or longer.

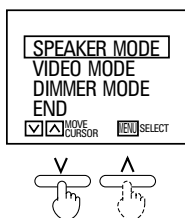

② Select the SPEAKER MODE.

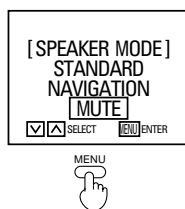

③ Press the MENU button.

Note

- If no operations are performed for a period of 30 seconds after pressing the MODE button: The Menu configuration screen automatically disappears.

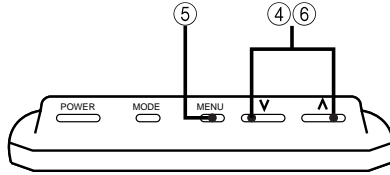

④ Select STANDARD.

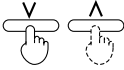
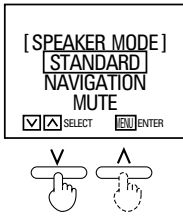

⑤ After the SPEAKER MODE screen disappears (occurs after about 10 seconds), press the Menu button for less than 2 seconds and show the speaker volume level display.



⑥ Adjust the speaker volume level.



Sound level (0-60 levels)

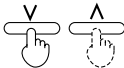

Note

- Relationship between the Speaker Mode setting and the built-in speaker volume

Speaker mode setting	Built-in speaker volume			
	Television	RGB	Video 1	Video 2
STANDARD	Television sound	—	Video 1 sound	Video 2 sound
NAVIGATION	Not used at present. Please select either STANDARD or MUTE.			
MUTE	There is no sound output from the speakers			

- Speaker output is monaural sound. (It is not heard as stereo sound.)

Adjusting the volume output level of the AV output terminal

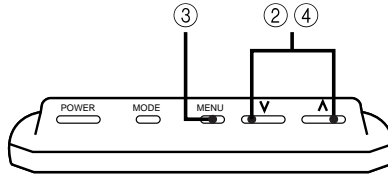

- ① Perform steps 1 to 3 on page 16.
 - Ⓐ Press the MODE button for 2 seconds or longer.
 - Ⓑ Select the SPEAKER MODE setting using the [V] and [^] buttons.
 - Ⓒ Press the MENU button.

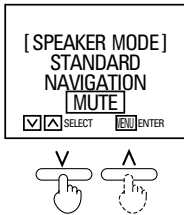

- ② Select MUTE.

Note

- When MUTE is selected in advance:

With the remote controller, the volume level can be adjusted directly using the volume button.

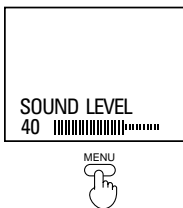

- ③ After the SPEAKER MODE setting screen disappears (occurs after about 10 seconds), press the MENU button for less than 2 seconds and show the volume level display.

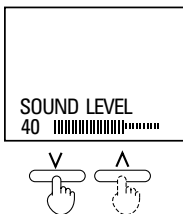

- ④ Adjust the volume output level of the AV output terminal.

Note

- When the SPEAKER MODE setting is on STANDARD:

The output level is fixed to the maximum of 60 and cannot be adjusted. (See page 17 for more details.)

Adjusting Brightness

For the automatic mode

(The TV tuner system is set to the Auto Mode at the time of shipment from the factory.)

Automatically adjusts the screen brightness to suit the brightness of the surrounding environment.

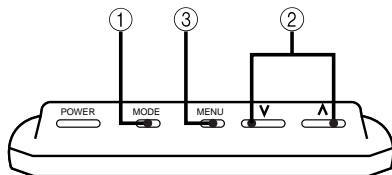

- ① Press the MODE button for 2 seconds or longer.

Note

- When END is selected, the system returns to the initial screen.

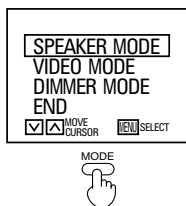

- ② Select the DIMMER MODE.

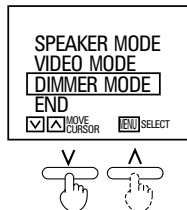

- ③ Press the MENU button.

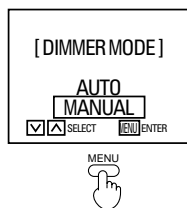

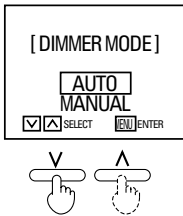
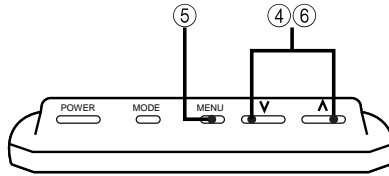

- ④ Select AUTO.

Note

- When the AUTO Mode is selected in advance:

With the wireless remote controller, it is possible to set this level directly using the Brightness button without having to bring up the DIMMER MODE screen.

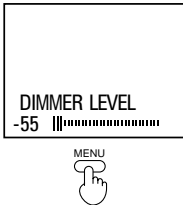

- ⑤ After the DIMMER MODE screen disappears (occurs after about 10 seconds), press the Menu button for less than 2 seconds and show the automatic dimmer (darkness level) display.

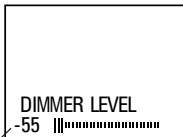

- ⑥ Use the [V] or [^] button to adjust brightness to the best visibility at night.

Note

- When the adjustment is made to the best visibility at night, the system automatically adjusts the level between the maximum brightness and the brightness for the best visibility at night (minimum brightness).

(It is recommended that the setting be put between -40 and -60).

- When 0 is set, the value is fixed to the maximum level and the brightness does not change.

When set to 0, the brightness does not change.

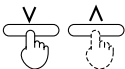

Adjusting Brightness

For the manual mode

The screen brightness can be adjusted manually.

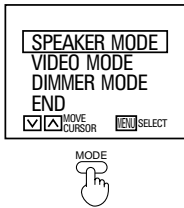
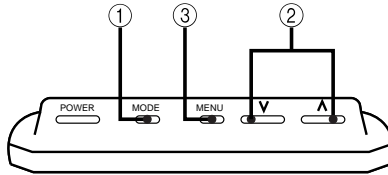

① Press the MODE button for 2 seconds or longer.

Note

- When END is selected, the system returns to the initial screen.

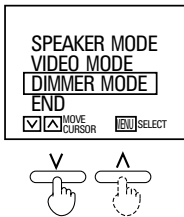

② Select the DIMMER MODE.

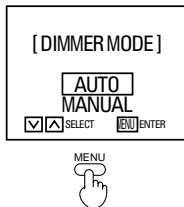

③ Press the MENU button.

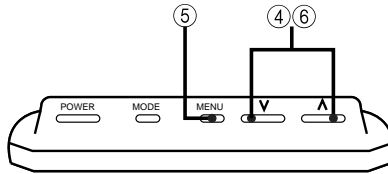

- ④ Select the MANUAL Mode.

Note

- When the MANUAL Mode is selected in advance:

With the wireless remote controller, it is possible to set this level directly using the Brightness button.

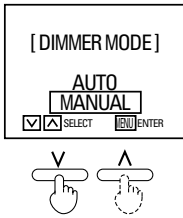

- ⑤ After the DIMMER MODE screen disappears (occurs after about 10 seconds), press the MENU button for less than 2 seconds and show the brightness display.

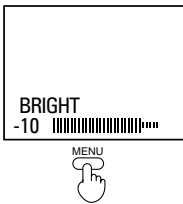

- ⑥ Use the [∨] or [∧] button to adjust the brightness to your preferred level.

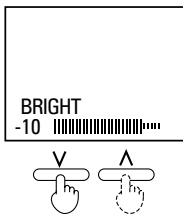

Adjusting the Sound

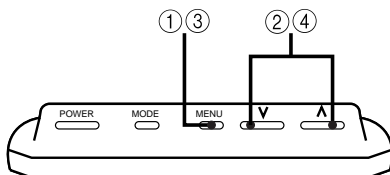

Example: Adjusting the bass level

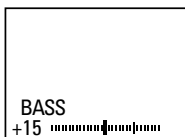
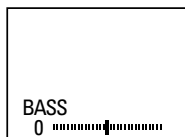

① Press the MENU button for 2 seconds or longer.

② Select BASS.

③ Press the MENU button.

④ Adjust the BASS level.

Note

- After 10 seconds passes:
The BASS Adjustment screen automatically disappears.

Note

- When END is selected, the system returns to the initial screen.
- Bass, Treble, Balance and Surround do not change in the case of a built-in speaker.

Adjustment points (The bass, treble and balance can be adjusted from the setting screens)

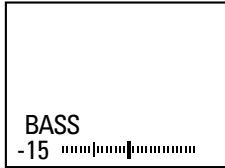

Bass is reduced.

BASS

(level of low tones)

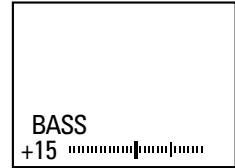

Bass is increased.

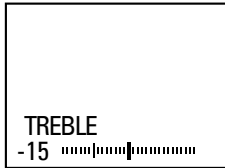

Treble is reduced.

TREBLE

(level of high tones)

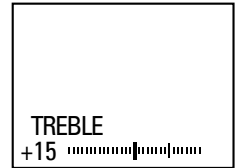

Treble is increased.

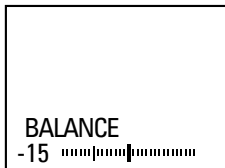

Sound output of the right side is lowered.

BALANCE

Balances the sound output between the left and right speakers

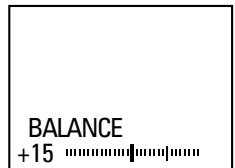

Sound output of the left side is lowered.

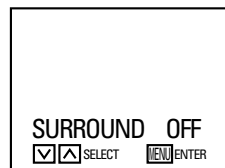

SURROUND

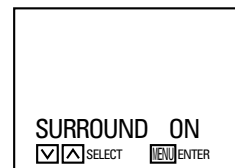

The feature gives a 3D effect to the sound when VIDEO1 or VIDEO2 is in stereo format.

Adjusting the Image

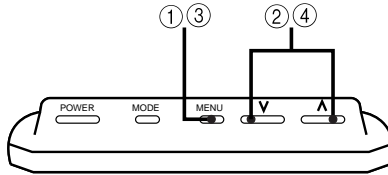

Example: Adjusting the black level

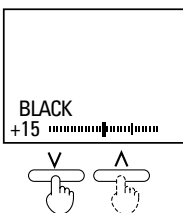
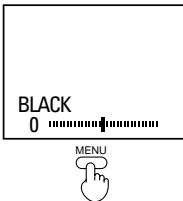
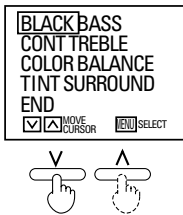
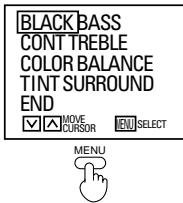

① Press the MENU button for 2 seconds or longer.

Note

- When END is selected, the system returns to the initial screen.
- For an RGB screen, only the Black level and Contrast are shown. (Not used at present.)
- If no operations are performed for a period of 30 seconds after pressing the MENU button
The Menu configuration screen automatically disappears.

② Select BLACK.

③ Press the MENU button.

④ Adjust the Black level.

Note

- After 10 seconds passes
The Black level adjustment screen automatically disappears.

Adjustment points (Image features can be adjusted from the various setting screens)

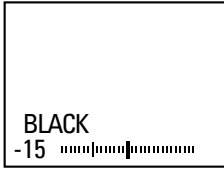

BLACK LEVEL

Makes the black portions of the screen easier to see (Night scenes, black hair, etc.)

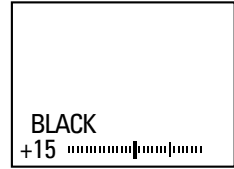

Adjust the Black Level when there is an inversion of the black and white on the screen or the screen appears too white due to an imbalance in the relationship between the installation position of the monitor and eye level.

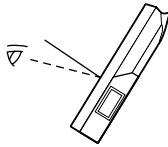

When the Black Level is on the negative [-] side.

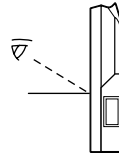

When the Black Level is on the positive [+] side.



CONTRAST

Normally set in the middle. Move to the right for more contrast.

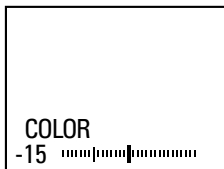

Colors are less vivid.

COLOR

Setting to slightly thicker colors

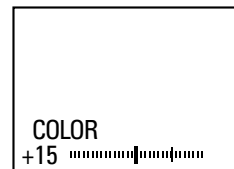

Colors are more vivid.



Skin color has a red-dish-purplish tint.

TINT

Setting for attractive skin color



Skin color has a greenish tint.

Connecting to External Devices

Connection example 1

Mobile video machine or video camera (AV input 1) and car stereo (Audio output)

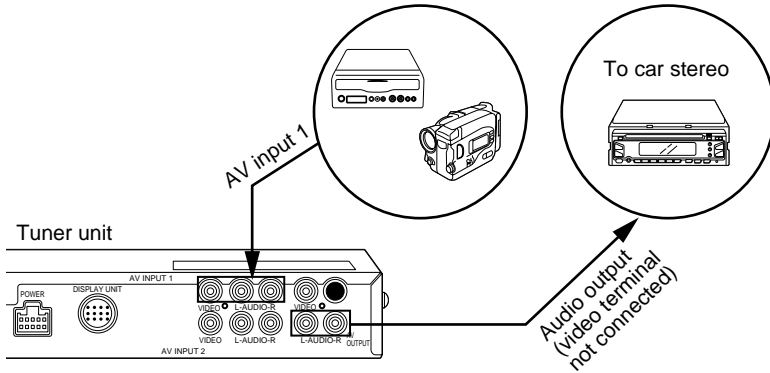

Connection example 2

Mobile video machine (AV input 1) and 2nd monitor (AV output)

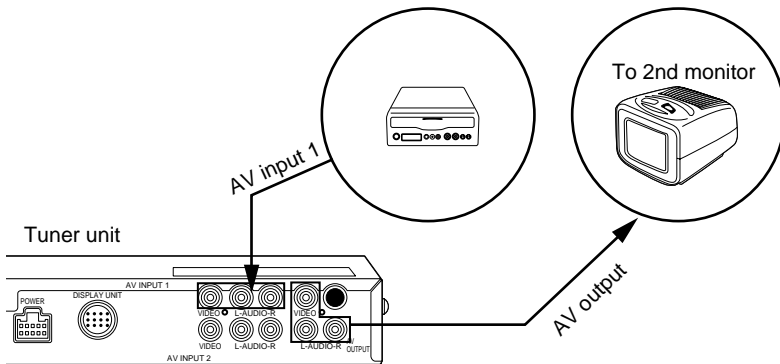













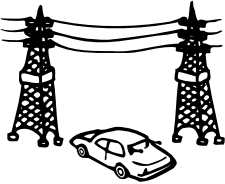
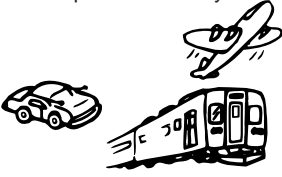

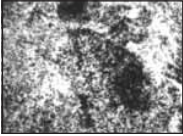
Note

- Refer to the installation manual for an explanation of how to make these connections.
- Since the connection cord varies depending on what external devices are connected, refer to the video equipment manual as well.
- For connection of a mobile video machine or video camera:
 - When howling (a "pi" sound) occurs, take one of the following steps.
 - Lower the volume on the TV tuner system
 - Use earphones (when the camera has an earphone jack)
 - Keep the tuner system and the camera microphone apart.

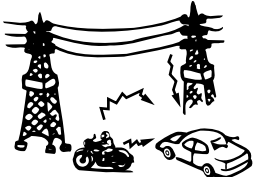

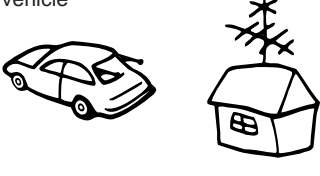
Troubleshooting

In the following environments, the image quality may be impaired.

 <p>Movement</p>  <p>Interference occurs</p>  <p>Doubling and tripling of images (ghosts)</p>	<p>Between buildings</p>  <p>Near electricity transmission wires</p> 	<p>A plane flies overhead A train passes close by</p>  <p>Mountain shadow</p> 
 <p>Interference occurs</p> <p>Image quality gradually worsens and color instability (displayed and then disappear)</p>	<p>Mountain or tree shadow</p> 	<p>Distance from the broadcast station</p> 
 <p>Normal sound</p> <p>Spots appear on the screen</p>	<p>Near an automobile, motor bike, high-voltage wires or a neon sign</p> 	
 <p>Normal sound</p> <p>Color patterns appear on the screen; colors are lost</p>	<p>Near the transmission antenna of a radio station or an amateur wireless station, or when a wireless device is being used in a vehicle</p> 	

When You Think There is a Problem

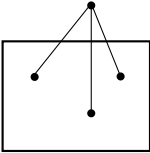
Please check the following items one more time.

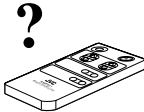
When this occurs	Check these points	Reference page
<p>There are red, blue and green spots on the screen.</p> 	<p>This is a characteristic of liquid crystal panels and is not a problem.</p> <p>(The liquid crystal panel is built with very high precision technology and has at least 99.99% effective image pixels. Be aware that on 0.01% of the panel there may be missing pixels or constantly light pixels.)</p> 	-
<p>There is sound output, but no video output (only the channel number is shown).</p>	<ul style="list-style-type: none"> • Is the parking brake connection wire (gray color) connected? • Was the parking brake lever pulled? 	Refer to the installation manual
<p>There is no television image and also no sound.</p>	<p>[Mode Button]</p> <ul style="list-style-type: none"> • Is the Mode button set to video input 1 screen or video input 2 screen or to RGB? 	11
<p>The wireless remote controller does not work.</p> 	<ul style="list-style-type: none"> • Has the battery run out? • Is a strong light shining on the remote controller receiver? • Is the remote controller for this tuner system being used? 	10
<p>There is no sound from the speakers.</p>	<p>[Speaker Volume Adjustment] Is the volume on the lowest level?</p> <p>[Speaker Output Setting] Is the setting on No Output?</p>	16, 17 18
<p>The screen is dark. The screen black and white portions are inverted. The screen is too white.</p>	<p>[Brightness, Black Level and Contrast]</p> <p>Are the settings properly adjusted?</p>	19 to 22 25, 26
<p>The color is thin. The tint is off.</p>	<p>[Color and Tint] Are the settings properly adjusted?</p>	25, 26

Maintenance

To prevent damage to the system exterior

Do not apply pesticides, benzine, thinner or other volatile substances to the unit.

The cabinet surface primarily consists of plastic materials.

Do not wipe with benzine, thinner or similar substances because this will result in discoloration or removal of the paint.

When a cloth with a cleansing chemical is used, follow the caution points.

Do not leave the unit in contact with rubber or vinyl products for long periods of time.

Do not use cleansers which have polishing granules because this could damage the surface of the unit.

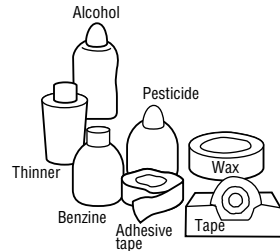

Clean dirt by wiping lightly with a soft cloth

When the unit is very dirty, wipe with a well-wrung cloth dipped in a kitchen cleanser (neutral) thinned by water and then go over the same surface with a dry cloth.

(Since there is the possibility of water drops getting inside of the unit, do not directly apply cleanser to the surface.)

① Wring well



Kitchen cleanser thinned by water

Wipe lightly



② Go over the same surface with a dry cloth



Request

If water drops or similar wet substances get inside of the monitor via the liquid crystal panel surface, it may cause a malfunction.

Specifications

Overall system	Product type	Mobile TV tuner system
	Power source voltage	DC 14.4V (can be used within the range of 11V to 16V); negative ground only
	Reception channels	VHF channels 2 to 12, UHF channels 13 to 69
	Usage temperature range	0°C to +40°C (32°F to 104°F)
	Storage temperature range	-20°C to +80°C (-4°F to +176°F)
Tuner unit	Connection terminals	<ul style="list-style-type: none"> • Power, ground, parking brake, remote output connection terminals (10 pin connector) • Diversity antenna connection terminal (75ohm/M3 mini jack) • Display unit connection terminal (13-pin DIN connector) • AV input 1 and input 2 terminals Video 1Vp-p(75Ω/RCA pin) Audio 0.5Vrms (RCA pin) • AV output terminal Video 1Vp-p(75Ω/RCA pin) Audio 0 to 0.5Vrms(RCA pin) (consecutive change supported by sound level adjustment)
	Dimensions	Width 19.6 cm (7-3/4"), depth 14.2 cm (5-5/8"), height 3.8 cm (1-1/2")
	Mass	930 g (2.1 lbs)
Wireless remote controller	Power source	DC 3V (lithium coin battery)
	Remote controller operation distance	Within a range of about 3 meters (distance from the front of the display)
	Dimensions	Width 4.0 cm (1-5/8"), length 8.6 cm (3-7/16"), height 0.7 cm (5/16")
	Mass	16 g (0.04 lbs) (without the battery)
Diversity antenna	Output impedance	75Ω x 4 (with mini plug)
	Cable length	4 m (13.3 ft)
	Dimensions	About width 46 cm (18-1/8"), height 46 cm (18-1/8"), depth 1.8 cm (3/4") (without the cable)
	Mass (each unit)	About 165 g (0.37 lbs) (including the cable)



JVC

VICTOR COMPANY OF JAPAN, LIMITED